



ЭВОЛЮЦИЯ ЭЛЕКТРОСНАБЖЕНИЯ ЦОД

Павел Топчиев, руководитель направления ЦОД



О КОМПАНИИ

более
20
ЛЕТ ОПЫТА

производство
электрооборудования

реализация
комплексных проектов

не менее
30
проектов в ЦОД



ЦЕНТРАЛЬНЫЙ
ВОЕННЫЙ ОКРУГ



Яндекс

Selectel

более
150
высокопрофессиональных
СОТРУДНИКОВ

Екатеринбург
Москва
Санкт-Петербург
Уфа
Новосибирск

ФОТО С ОБЪЕКТОВ



ЭВОЛЮЦИЯ ЭЛЕКТРОСНАБЖЕНИЯ



ЭВОЛЮЦИЯ ЭЛЕКТРОСНАБЖЕНИЯ

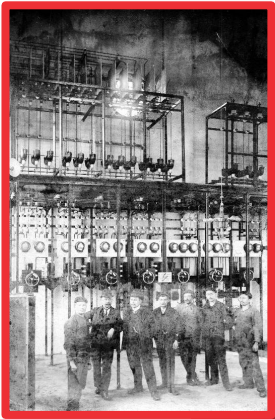
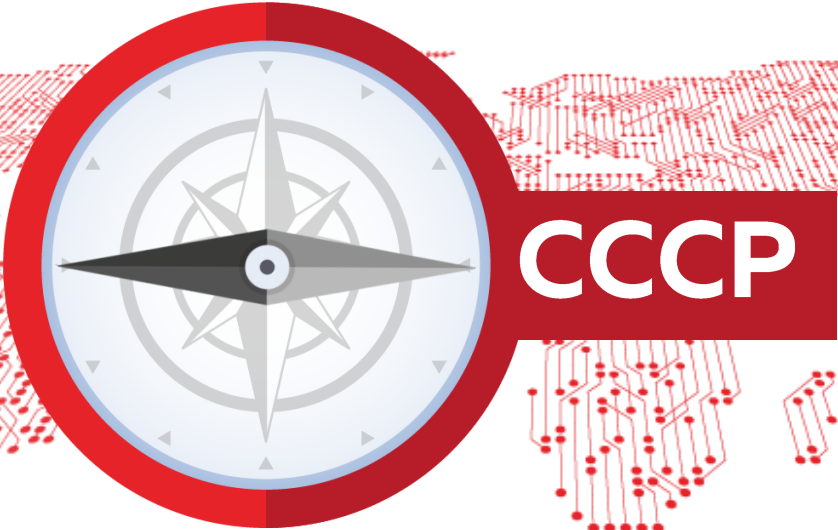

ЭВОЛЮЦИЯ ЭЛЕКТРОСНАБЖЕНИЯ



ЕВРОПА

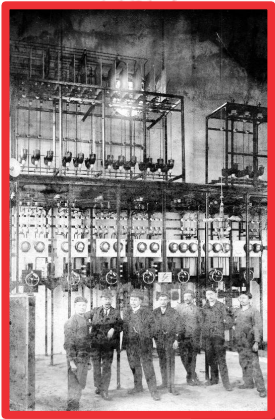

ЭВОЛЮЦИЯ ЭЛЕКТРОСНАБЖЕНИЯ



Юго-Восточная Азия

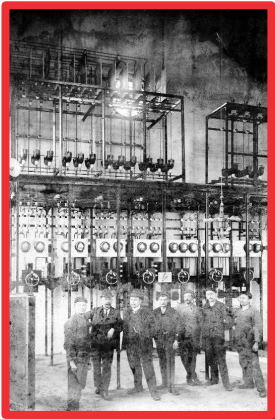

ЭВОЛЮЦИЯ ЭЛЕКТРОСНАБЖЕНИЯ

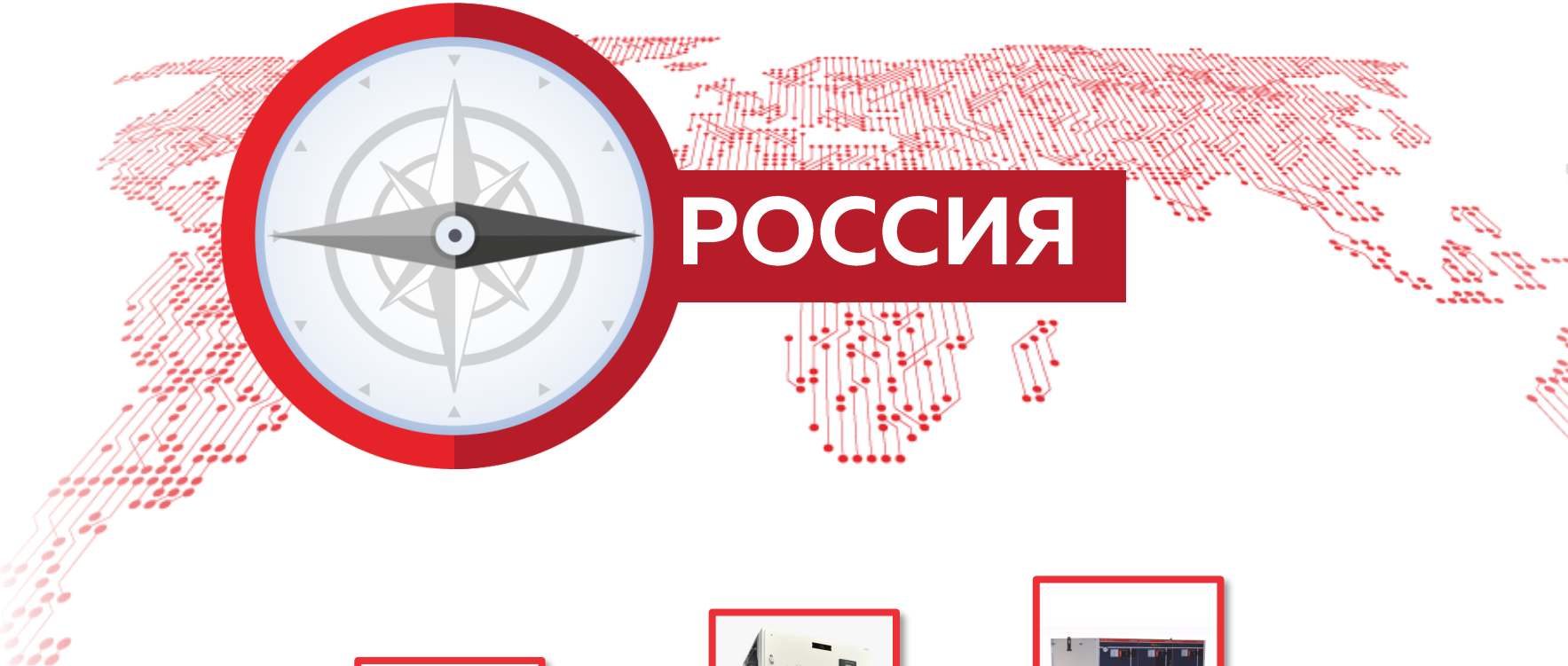

РОССИЯ

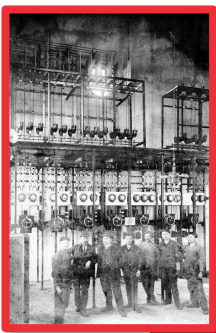

КРУ EVOLUTION

Современное решение

Гибкость схемных решений

Удобство монтажа

Возможность расширения



Компактность, модульность

Надежность и безопасность

Технологичность и качество

Экологичность

EVOLUTION PL

Модульная ячейка

НАДЕЖНОСТЬ В ДЕТАЛЯХ



КРУ EVOLUTION

Надежность и безопасность



ПРИМЕР СХЕМЫ ЭЛЕКТРОСНАБЖЕНИЯ ЦОД

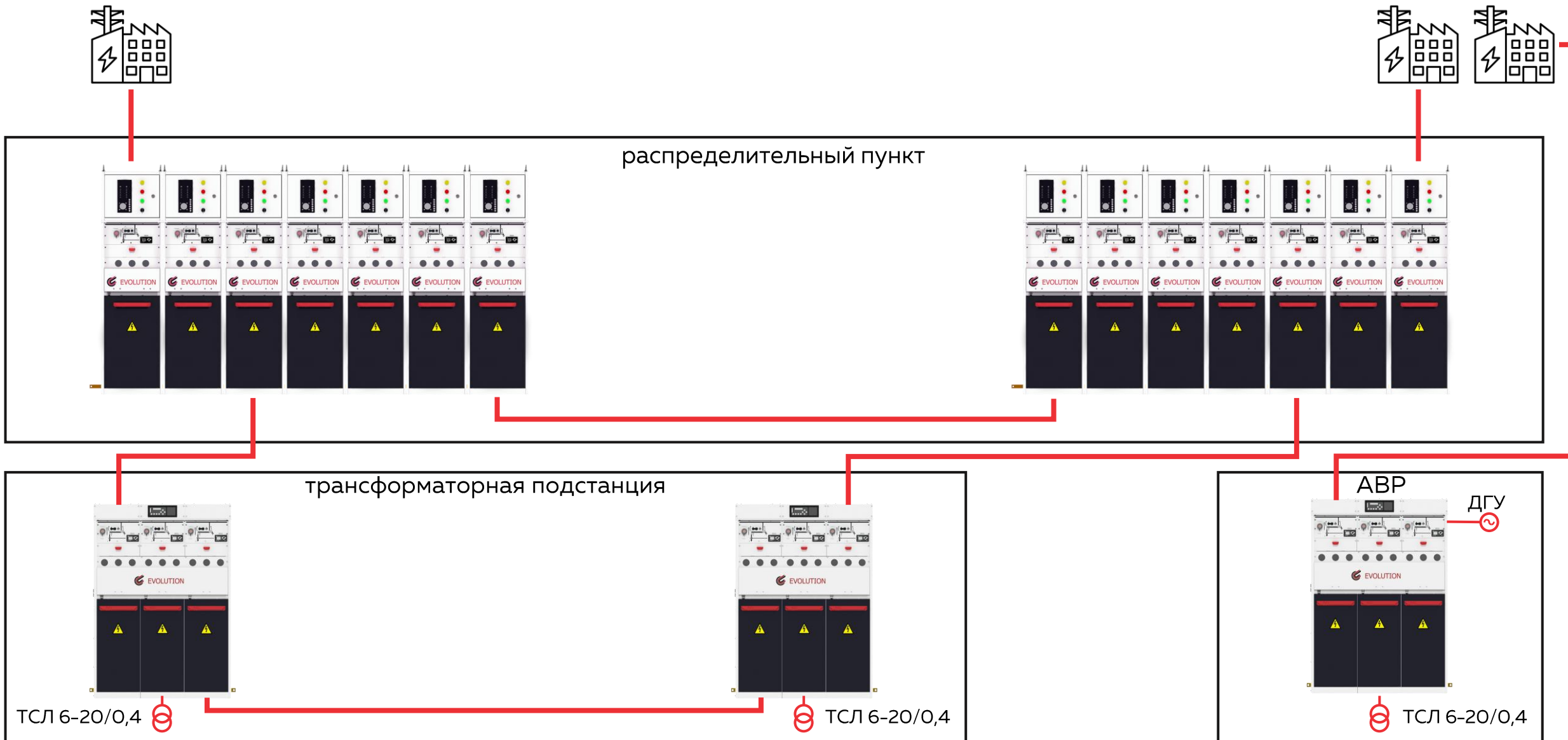

НОВОЕ ПРОИЗВОДСТВО



СДЕЛАНО НА УРАЛЕ



КТП ИСЕТЬ – Решение «под ключ»

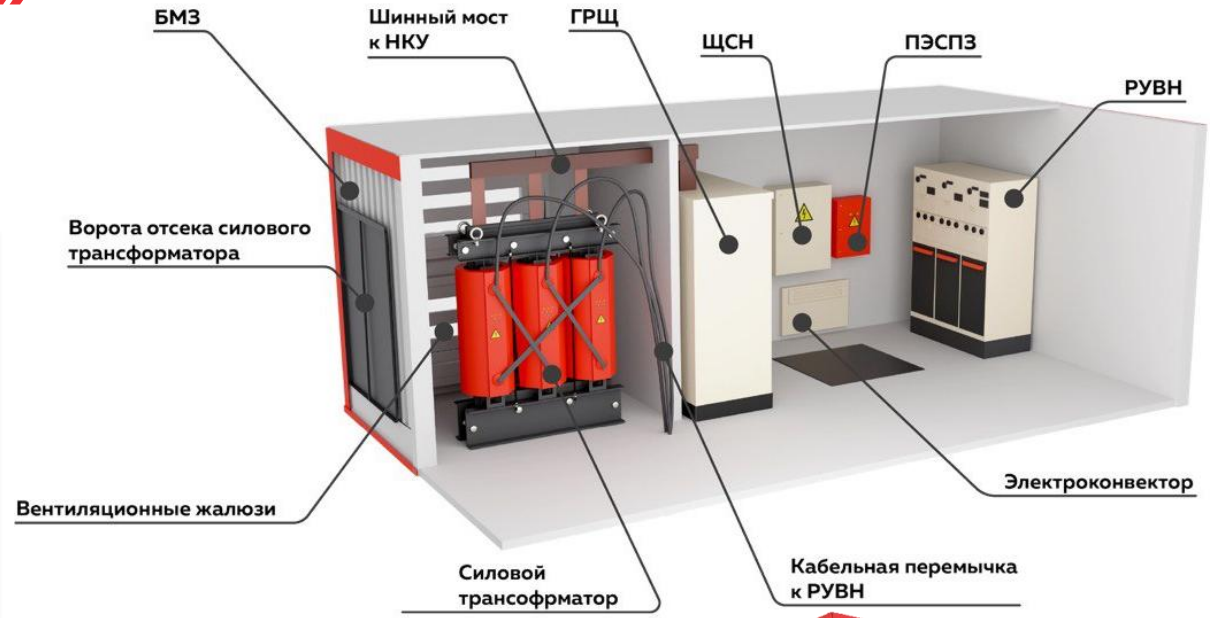





контактные данные

Павел Топчиев,
руководитель направления ЦОД

